

1 2 3 4 5 6 7

A

B

C

D

E

F

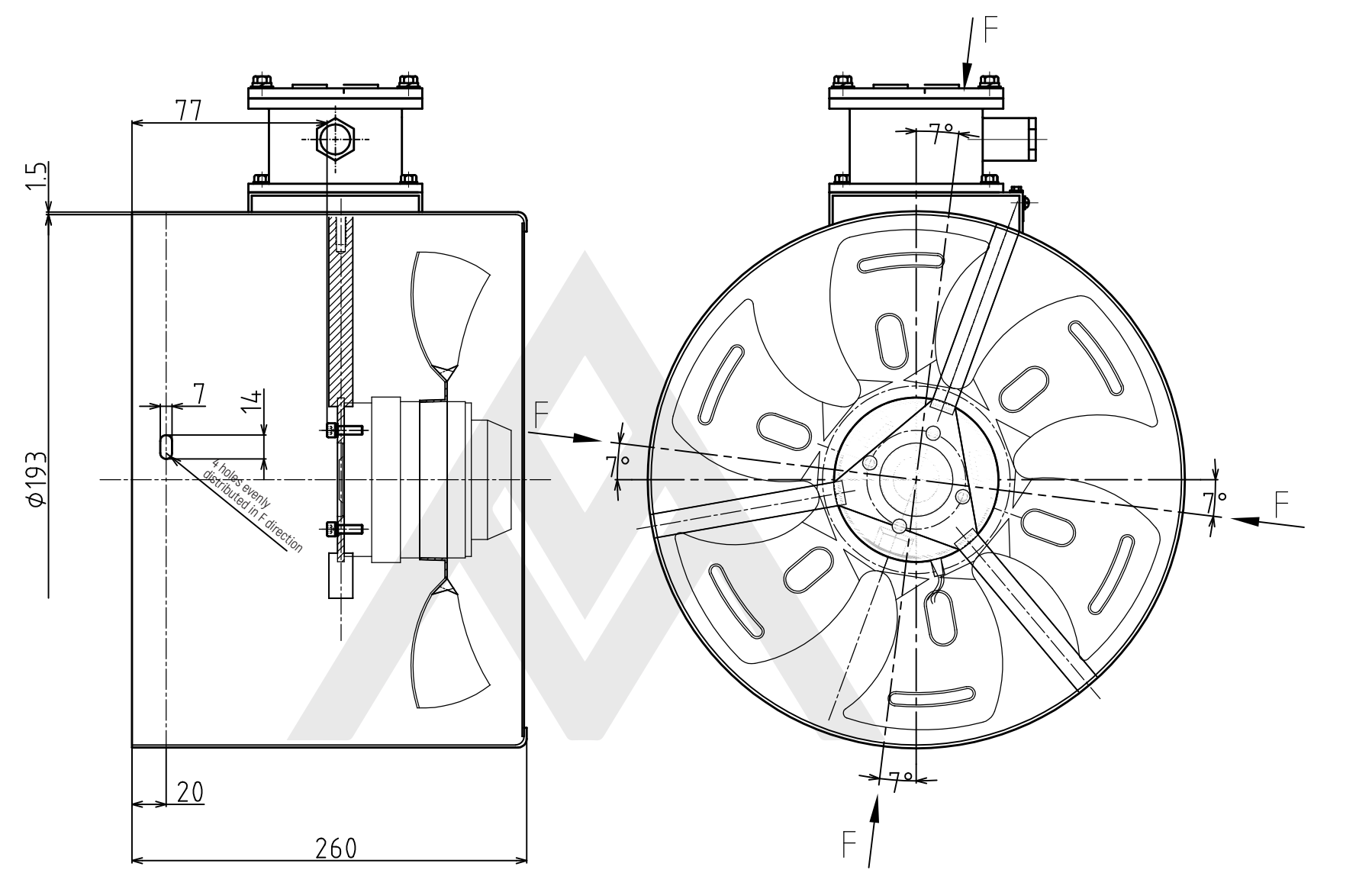

A

B

C

D

E

F

FZB100 Fan assembly drawing universal explosion-proof fan		WEIGHT		
		INVERSE PROPORTION		
ISSUE	A	DATE	CERTIFIED BY	
ISSUE	B	DATE	CERTIFIED BY	
ISSUE	C	DATE	CERTIFIED BY	
ISSUE	D	DATE	CERTIFIED BY	

1 2 3 4 5 6 7

G